

Article number: 2310309541ESD

Description: E+G Antistatic base for levelling elements
LV.A-100-24-AS-M16x138-ESD-C

Measures

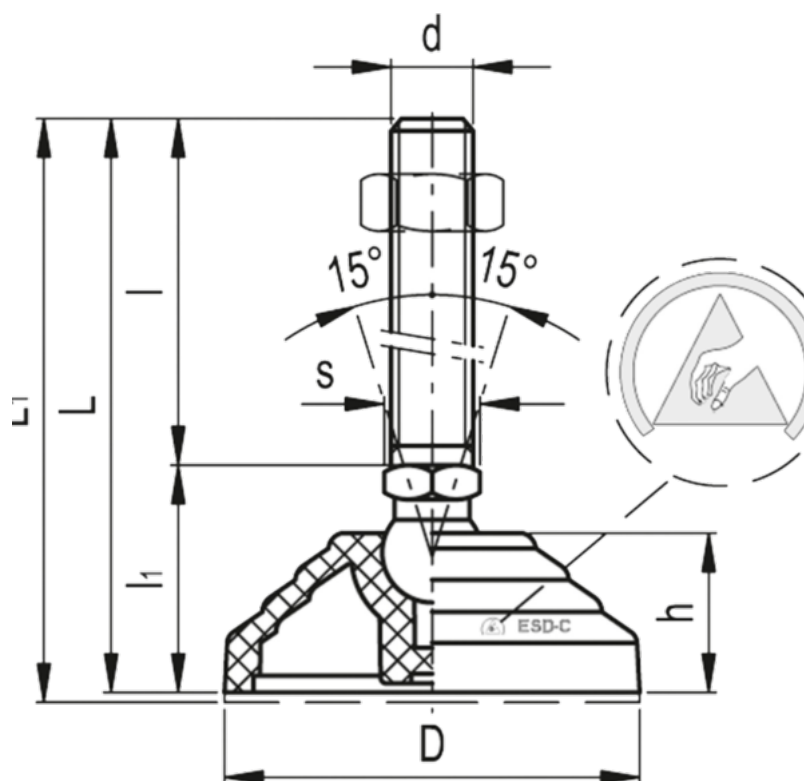

Articulation = 24	Max load = 25000
D = 100	s = 24
d = M16	Weight in (g) = 406
h = 24	
l = 138	
l1 = 43	
L = 181	
L1 = 184	